









Features:

- Cast brass spout and valves
- Ceramic disc valve cartridge
- Flexible Hose Connections for 8"-12" installations
- Available in 5 handle options
- Available with or without Hand Shower
- Hand Shower features 6-1/2 ft (2m) metal hose



Pictured: 855/996 Roman Tub Set with Hand Shower w/ Curved Levers

Maximum Hand Shower Flow Rate: 2.5 GPM (9.5L/min)

| Kit Options | Handle Type | Product Number | |
|-----------------------------|-----------------|----------------|---|
| Roman Tub Set | Cross | 855/986 | |
| Roman Tub Set | Straight Lever | 855/993 |  |
| Roman Tub Set | Curved Lever | 855/994 |  |
| Roman Tub Set | Porcelain Lever | 855/987 |  |
| Roman Tub Set | Crystal Lever | 855/887 |  |
| Roman Tub Set w/Hand Shower | Cross | 855/990 | |
| Roman Tub Set w/Hand Shower | Straight Lever | 855/995 |  |
| Roman Tub Set w/Hand Shower | Curved Lever | 855/996 |  |
| Roman Tub Set w/Hand Shower | Porcelain Lever | 855/999 |  |
| Roman Tub Set w/Hand Shower | Crystal Lever | 855/899 |  |

| Available Finishes: | Finish Code |
|---------------------|-------------|
| Polished Chrome | 100 |
| Old Bronze | 105 |
| Brushed Nickel | 144 |
| Platinum Nickel | 150 |
| Diamond (PVD) | 167 |

| Porcelain Finishes: | Finish Code |
|---------------------------------|-------------|
| Brushed Nickel/White Porcelain | 124 |
| Polished Chrome/White Porcelain | 128 |
| Platinum Nickel/White Porcelain | 152 |

ROUGH-IN DIAGRAM SHOWN ON REVERSE SIDE

Handle Options:



Curved Lever



Straight Lever



Porcelain Lever

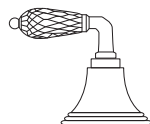

Crystal Lever

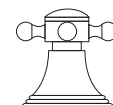

Cross Handle

CODES & STANDARDS

These products meet and exceed the following codes and standards:

ASME A112.18.1

CSA B125



Meets the American Disabilities Act Guidelines and **ANSI A117.1** Requirements for the physically challenged.

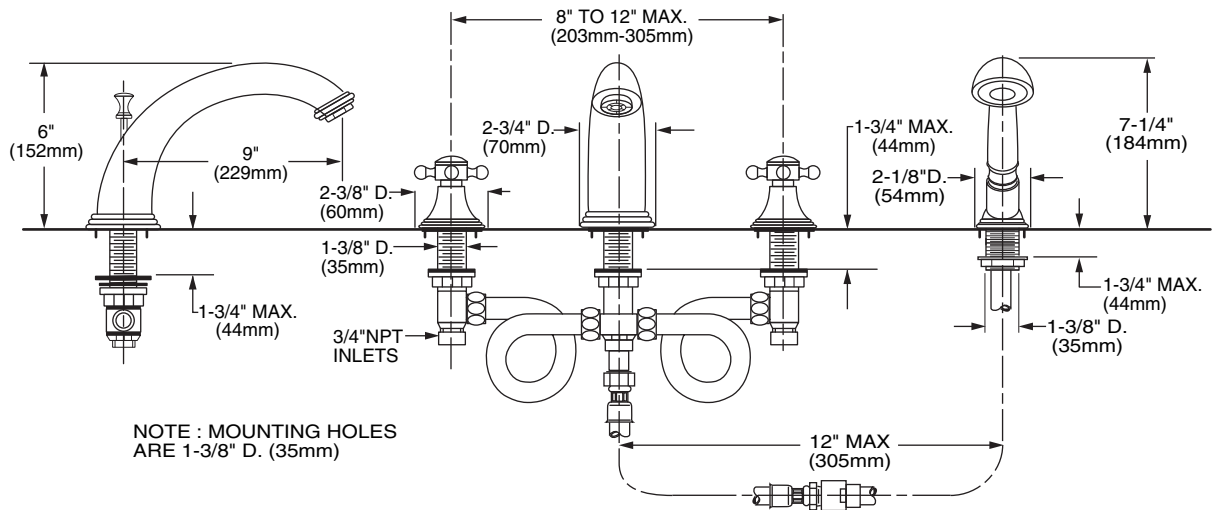
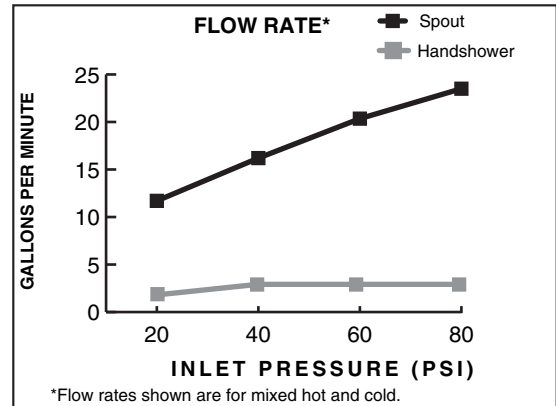

IMPORTANT: These measurements are subject to change or cancellation. No responsibility is assumed for use of superseded or voided pages.