









### Features:

- Cast brass spout and valves
- Ceramic disc valve cartridge
- Flexible Hose Connections for 8"-12" installations
- Available in 5 handle options
- Available with or without Hand Shower
- Hand Shower features 6-1/2 ft (2m) metal hose



Pictured: 855/996 Roman Tub Set with Hand Shower w/ Curved Levers

Maximum Hand Shower Flow Rate: 2.5 GPM (9.5L/min)

Kit Options	Handle Type	Product Number	
Roman Tub Set	Cross	855/986	
Roman Tub Set	Straight Lever	855/993	
Roman Tub Set	Curved Lever	855/994	
Roman Tub Set	Porcelain Lever	855/987	
Roman Tub Set	Crystal Lever	855/887	
Roman Tub Set w/Hand Shower	Cross	855/990	
Roman Tub Set w/Hand Shower	Straight Lever	855/995	
Roman Tub Set w/Hand Shower	Curved Lever	855/996	
Roman Tub Set w/Hand Shower	Porcelain Lever	855/999	
Roman Tub Set w/Hand Shower	Crystal Lever	855/899	

Available Finishes:	Finish Code
Polished Chrome	100
Old Bronze	105
Brushed Nickel	144
Platinum Nickel	150
Diamond (PVD)	167

Porcelain Finishes:	Finish Code
Brushed Nickel/White Porcelain	124
Polished Chrome/White Porcelain	128
Platinum Nickel/White Porcelain	152

ROUGH-IN DIAGRAM SHOWN ON REVERSE SIDE

### Handle Options:



Curved Lever



Straight Lever



Porcelain Lever

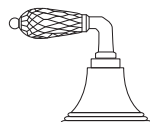

Crystal Lever

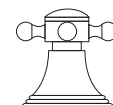

Cross Handle

### CODES & STANDARDS

These products meet and exceed the following codes and standards:

**ASME A112.18.1**  
**CSA B125**

 Meets the American Disabilities Act Guidelines and **ANSI A117.1** Requirements for the physically challenged.

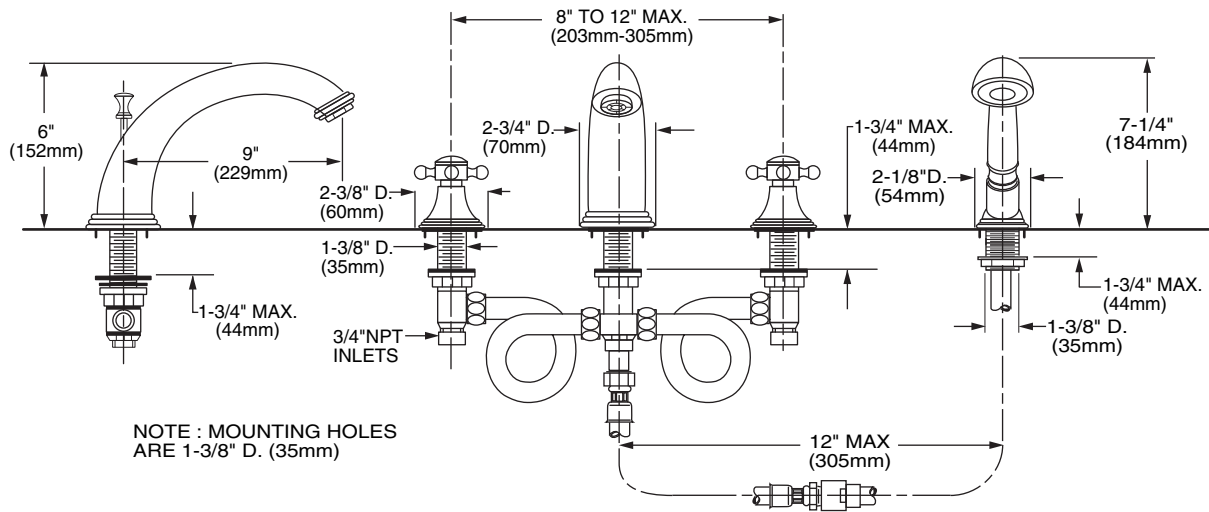
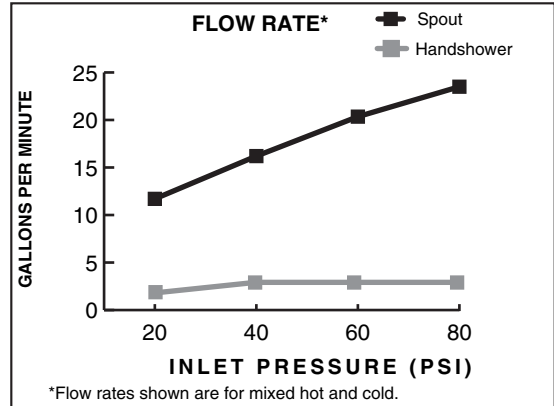

**IMPORTANT:** These measurements are subject to change or cancellation. No responsibility is assumed for use of superseded or voided pages.