





Features:

- Cast brass spout and valves
- Ceramic disc valve cartridges
- Flexible Hose Connections for 8"-12" installations
- Available in 3 handle options
- Available with Hand Shower
- Hand Shower features 5 ft (1.5m) metal hose
- Hand Shower Maximum Flow Rate: 2.5 GPM (9.5L/min.)

Pictured:

855/899 Deck Mount Tub Filler with Hand Shower and Crystal Lever Handles

Description	Handle Type	Product Number	Available Finishes	Finish Code
Tub Filler with Hand Shower	Cross	855/990	Polished Chrome	100
Tub Filler with Hand Shower	Straight Lever	855/995 	Brushed Nickel	144
Tub Filler with Hand Shower	Crystal Lever	855/899 	Platinum Nickel	150

ROUGH-IN DIAGRAM
SHOWN ON REVERSE SIDE

Handle Options:

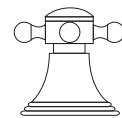

Cross Handle



Straight Lever

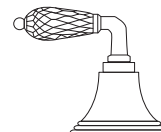

Crystal Lever



CODES & STANDARDS

These products meet and exceed the following codes and standards:

- ASME A112.18.1
- CSA B125.1

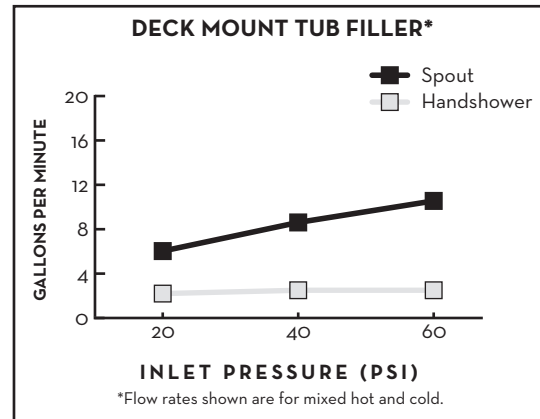

 Meets the American Disabilities Act Guidelines and **ANSI A117.1** Requirements for the physically challenged.

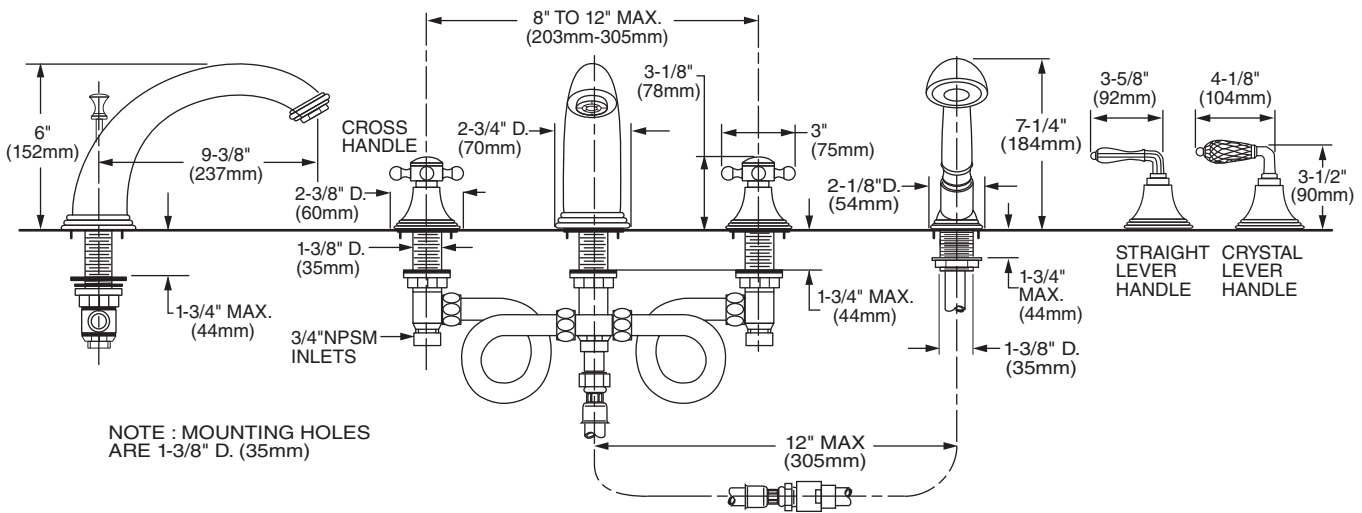

IMPORTANT: These measurements are subject to change or cancellation. No responsibility is assumed for use of superseded or voided pages.