







Features:

- Ceramic disc valve cartridge
- Cast brass valve body with built-in check stops
- Adjustable hot limit safety stop
- Wax Thermostatic Unit permits shuttle valve to move between the hot and cold seats to maintain the preselected constant water temperature
- Concealed mounting hardware
- Available in 3 Handle Options
- Maximum Temperature Limit: 112°

Pictured:

875/892 Thermostatic Mixing Valve with Straight Lever Handle

Description	Handle Type	Product Number
1/2" Thermostatic Mixing Valve	Cross	875/785
1/2" Thermostatic Mixing Valve	Straight Lever	875/787 
1/2" Thermostatic Mixing Valve	Crystal Lever	875/789 
3/4" Thermostatic Mixing Valve	Cross	875/780
3/4" Thermostatic Mixing Valve	Straight Lever	875/892 
3/4" Thermostatic Mixing Valve	Crystal Lever	875/899 

Available Finishes	Finish Code
Polished Chrome	100
Brushed Nickel	144
Platinum Nickel	150

Rough & Trim Options	Handle Type	Product Number
Trim Only	Cross	875/771
Trim Only	Straight Lever	875/792 
Trim Only	Crystal Lever	875/799 
1/2" Rough Only		875/612/191
3/4" Rough Only		875/614/191

Extension Kit	Product Number
Handle Extension Kit	H960892.191

ROUGH-IN DIAGRAM
SHOWN ON REVERSE SIDE

Handle Options:

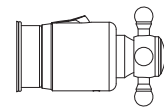

Cross Handle

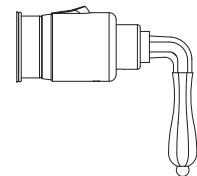

Straight Lever

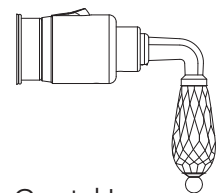



Crystal Lever

CODES & STANDARDS

These products meet and exceed the following codes and standards:

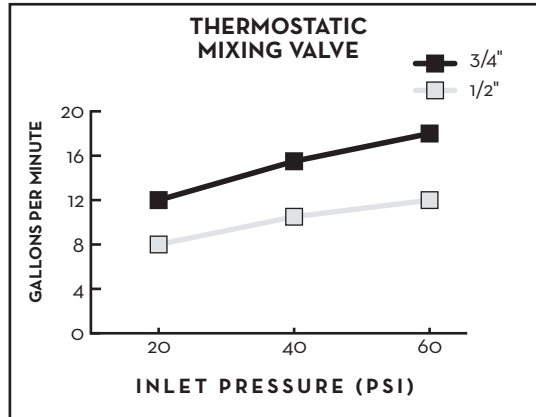
- ASME A112.18.1
- CSA B125.1
- ASSE 1016



 Meets the American Disabilities Act Guidelines and ANSI A117.1 Requirements for the physically challenged.

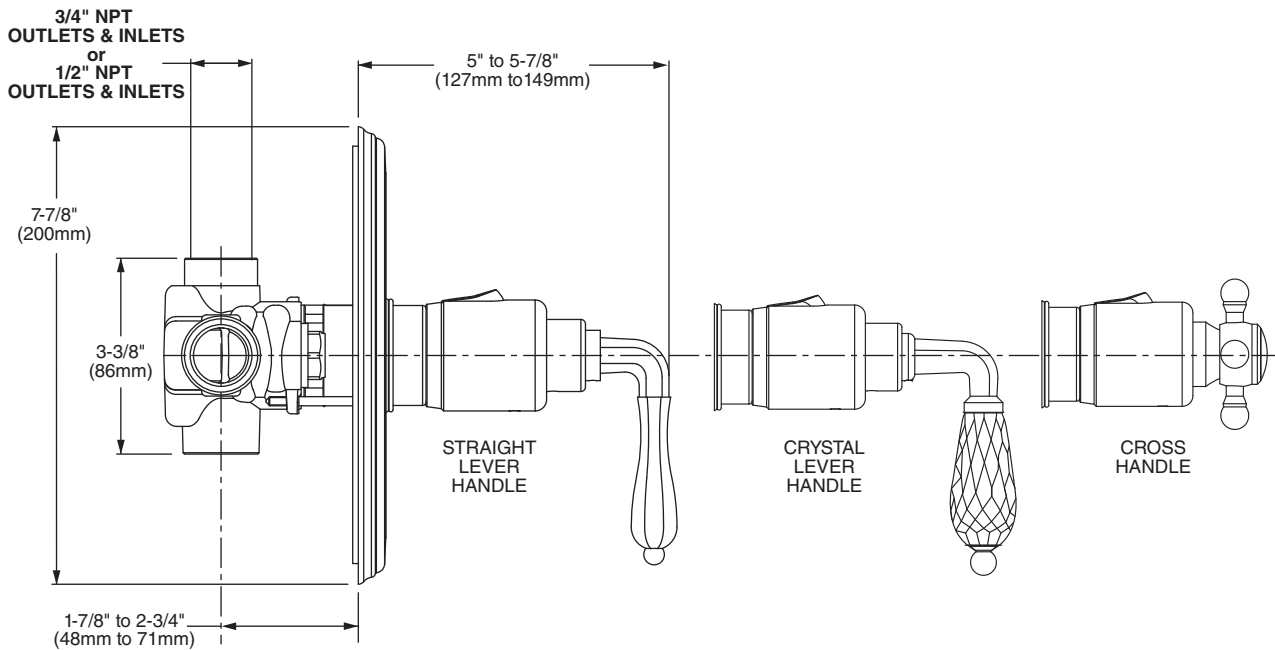

IMPORTANT: These measurements are subject to change or cancellation. No responsibility is assumed for use of superseded or voided pages.